

# Component Product Overview



**Ammeraal Beltech** serves as your **One-Stop-Shop** solution for all your conveying needs, leveraging decades of global experience. Our component offering is designed to improve and enhance your conveyor system in tandem with our **slat top chain, modular,** and **synthetic** belt products.

### Industries Served

- Bakeries
- Beverage
- Bottling, Canning, and Packaging
- Food Packaging and Processing
- General Packaging
- Hygiene
- Pharmaceutical Packaging
- Electronic Packaging
- Agriculture

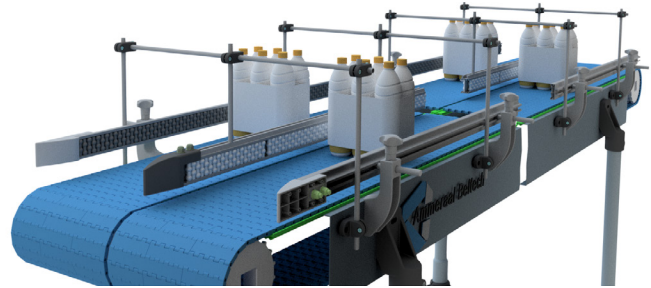

### UHMW Components

Features	Benefits
Low Friction	The low friction properties of UHMW conveyor components minimize resistance, leading to smoother movement and decreased energy requirements, ultimately optimizing operational efficiency and reducing power consumption.
Corrosion and Chemical Resistance	The exceptional corrosion and chemical resistance ensures a longer operational life, reducing maintenance needs and associated downtime.
Noise Reduction	UHMW noise reduction improves overall working environment conditions.
Self-Lubrication	Reduces the need for frequent maintenance, ensuring consistent and smooth conveyor operation.
No moisture absorption	Ensures consistent material properties over time, preventing degradation, warping, or swelling.

# Your Curve and Straight Strack Partner

## New Builds

Contact us for recommendations on new track designs to ensure the correct materials are being selected.



## Replacement Tracks

Normal signs of curve wear are:

- Increased conveyer noise
- Product tipping over
- Cracking of flights or chain lifting off of the curve

### Curve Track:

- Material: \_\_\_\_\_  
 Angle: \_\_\_\_\_  
 Width (W) \_\_\_\_\_  
 Thickness (H): \_\_\_\_\_  
 Tangents (T1) \_\_\_\_\_  
 Tangents (T2) \_\_\_\_\_  
 Chain No. and Width \_\_\_\_\_  
 CL Radius (CL1) \_\_\_\_\_  
 Dual Lane Curve Track \_\_\_\_\_  
 CL Radius 2 (CL2) \_\_\_\_\_  
 CL Radius 3 (CL3) \_\_\_\_\_  
 Quantity: \_\_\_\_\_

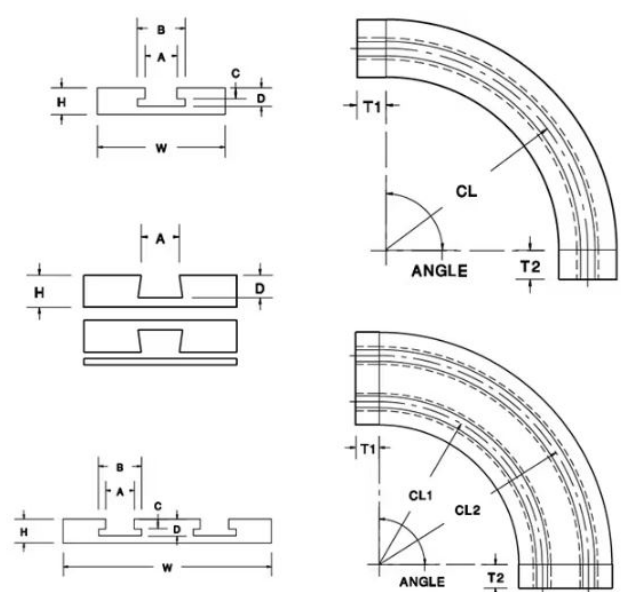

**Fill out the attached form to have a custom track quote!**

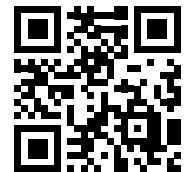

### Straight Track:

- Material: \_\_\_\_\_  
 Angle: \_\_\_\_\_  
 Width (W) \_\_\_\_\_  
 Thickness (H): \_\_\_\_\_  
 Length: \_\_\_\_\_  
 Chain No. and Width: \_\_\_\_\_  
 Quantity: \_\_\_\_\_

# Material Properties Guide (Standard)

Material	Description	Standard Color(s)	Approvals	Components	Recommended Applications
Nat. UHMW	Natural UHMW is approved for direct food contact and will not absorb water.	White	FDA, USDA, 3-A Dairy	Extruded profiles, guides, wearstrips, tracks, custom machined components.	Industry standard for conveyors and packaging machinery.
Repro/UHMW	Reprocessed UHMW contains 50% recycled UHMW.	Black or Green (may have multi-colored flecks)	NA	Extruded profiles, guides, wearstrips, tracks, custom machined components.	Used in the same applications as natural UHMW, but it is not approved for food contact.
OF/UHMW	Oil-filled UHMW reduces friction as it has a homogeneously dispersed lubricant throughout the UHMW, so as the part becomes worn down, fresh lubrication is exposed. The reduction of friction and wear resistance will result in a longer lifespan of components using OF/UHMW. Lubrication will also reduce noise.	Gray	FDA & USDA	Extruded profiles, guides, wearstrips, and tracks.	For high-speed applications such as bottling and food processing.
CS/UHMW	Anti-static material specifically formulated to dissipate static charges, reducing the risk of electrostatic discharge (ESD). Designed to meet cleanliness standards of cleanroom environments.	White	FDA, USDA, 3-A Dairy	Extruded profiles, guides, wear strips, machined components.	Applications where maintaining a clean and static-free environment essential, such as semiconductor mfg, medical device production and pharmaceuticals.
DS/UHMW	Anti-static formula uses a dry-lubricant formula to reduce surging in dusty environments.	Gray or Yellow	NA	Extruded profiles, guides, wear strips and transfers.	Applications where low friction and static dissipation are crucial, such as electronic mfg, parcel handling, or distribution centers.
AS/UHMW	Anti-static formula provides protection from electrical charge build-up	Black	NA	Extruded profiles, guides, wear strips, bearings, transfers.	Used in chemical, explosive, electronic or package handling facilities.
CP/UHMW	Glass beads increase the surface hardness and strength, while also maintaining dimensional stability over-time. Glass beads also enhance the resistance to certain chemicals and solvents.	Lime Green or Dark Blue	NA	Bushings, guides and other machined components.	For facilities handling abrasive products like glass, heavy loads, or for high speed applications. Used in facilities managing batteries, or other corrosive products.
HT/UHMW*	High temperature UHMW maintains its mechanical properties and wear resistance at elevated temperatures.	White	FDA, USDA, 3-A Dairy	Chain guides, tracks, and machined components.	Wear parts used close to ovens, heat shrink tunnels, PET bottle production, or where heat cleaning is used. HT UHMW is advantageous over Teflon (500°F) as it is 1/10 of the price and has longer wear resistance and strength compared to Teflon.
UV/UHMW	UV-resistant UHMW is formulated to prevent the polymer chains from breaking down from prolonged exposure to ultraviolet (UV) radiation. This makes it ideal for outdoor applications where exposure to sunlight is a concern. Reduces the need for frequent replacements and upkeep in outdoor settings.	NA	NA	Chain guides, tracks, and machined components.	Used in outdoor applications such as construction, agriculture or amusement park rides.
HP UHMW	Reduces friction with a dry lubricant dispersed throughout the plastic. The dry lubricant will not attract dust making it suitable for areas where there is no washdown.  Coefficient of sliding friction under dry conditions is 75% less in applications using acetal as a sliding partner and 60% less in applications using steel as a sliding partner on natural UHMW.	Light Blue	FDA	Chain guides, tracks, and machined components.	Used in applications with multiple turns or tight radii or areas of conveyors using high speeds and heavy loads.  Lower energy consumption and will help minimize the slip-stick effect which provides more product stability.

\*All UHMW is rated to <180°F, except HT, which is rated to <275°F.

## Material Properties Guide (Detectable)

Material	Description	Standard Color(s)	Approvals	Components	Recommended Applications
Blue UHMW	Blue virgin UHMW is used to easily detect if plastic particles have entered food.	Blue	FDA	Extruded profiles, guides, wearstrips, custom machined components.	Food products to be easily detected if it ends up in the product.
Metal Detectable UHMW	The metal content in this UHMW gives the ability for metal detectors to find particles as small as 3mm cubes.	Dark Blue	FDA	Extruded profiles, guides, wearstrips, custom machined components.	Applications where metal detectable belt or chain are used such as bulk or packaged food accumulation areas.
X-Ray Detectable UHMW	Fillers added that can be picked up by x-ray machines in as small as 3mm cubes.	Blue	FDA	Extruded profiles, guides, wearstrips, custom machined components.	Like metal detectable materials, this should be used in areas where wear parts are exposed to constant, heavy loads that may eventually cause particles to break off from the wear parts.

## Non-UHMW Material Properties Guide

Material	Description	Standard Color(s)	Approvals	Components	Recommended Applications
MD-Nylon	Nylon with a molybdenum disulfide filler. The addition of the MD crystalline structure provides for improved wear-resistance and compression strength compared to natural nylon.	Grey	FDA	Corner tracks, guides.	Ideal for high-speed, high load capacities.
OF Nylon	Oil filled nylon is a type of nylon that has been infused with oil during the manufacturing process. This reduces the friction between moving parts, contributing to smoother, efficient operation as well as extended the lifespan of the component.	Grey	FDA	Corner tracks and guides.	Ideal for high-speed, high load capacities.
PTFE	PTFE operates up to 450°F. It is glass and graphite filled to improve overall load capacity.	White	FDA	Wear strips and bearings.	Used for highly corrosive or chemically reactive facilities. It is easy to clean due to the non-stick properties.

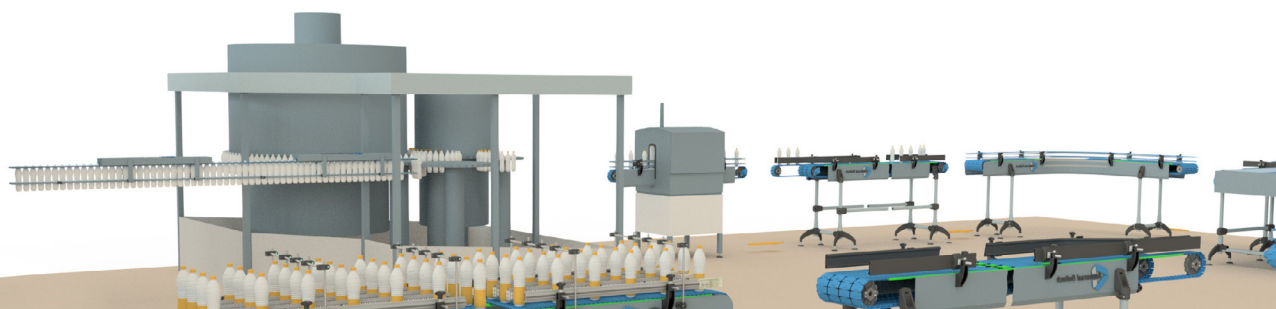



# Standard Components

## Extruded Profiles

- Extruded profiles can be used as belt guides, guide rails, and protective edging.
- High-impact resistance which will not mar cans or bottles.
- All part numbers below are supplied in Natural White UHMW.
- Contact us for additional configuration and material needs.

**J-LEGS available for 1/8", 3/16" and 1/4" Bar**  
(Options below are all for 1/8" Bar Thickness)

Part No	Sold By	A	B
EXPJL181018	500 ft coil	1/8"	1"
EXPJL1811218	250 ft coil	1/8"	1.5"
EXPJL182018	250 ft coil	1/8"	2"
EXPJL183018	20 ft coil	1/8"	3"

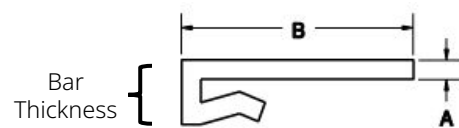

**Edge Guide J-LEGS available for 1/8" Thick Rail**

Part No	Sold By	A	B
EXPJL181888	250 ft coil	0.88"	1/8"
EXPJL181896	250 ft coil	0.96"	1/8"

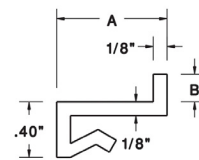

**Edge Guide J-LEGS available for 1/8" Thick Rail**

EXPJL183418

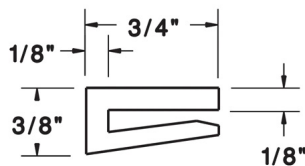

EXPJL183438  
(Oil filled UHMW)

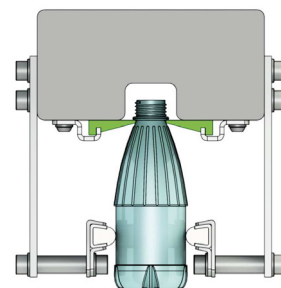
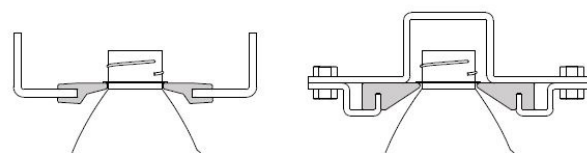
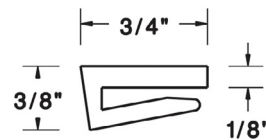

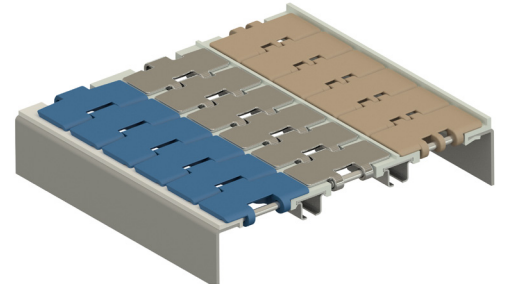

## Extruded Profiles

### UHMW Snap-Ons

3/16" Rail

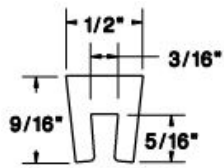

EXPSO316916

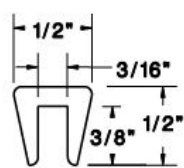

EXPSO31612

1/4" Rail

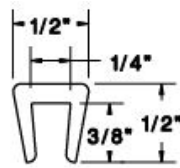

EXPSO316916

1/8" Rail

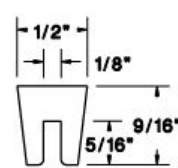

EXPSO18916

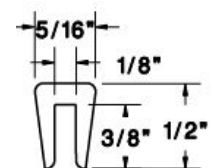

EXPSO1812

### UHMW Rail Covers

1"

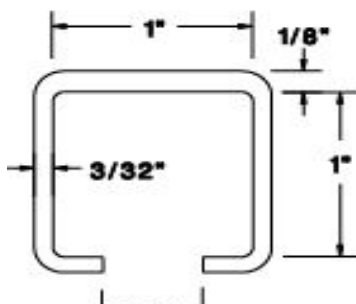

EXPGRC11

1.5"

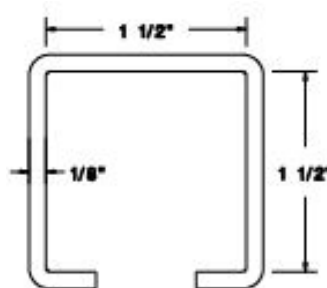

EXPGRC112112

2.0"

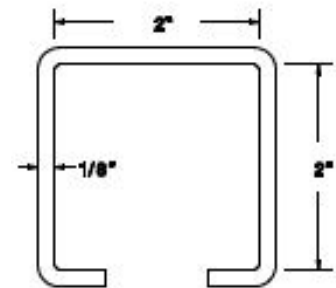

EXPGRC22

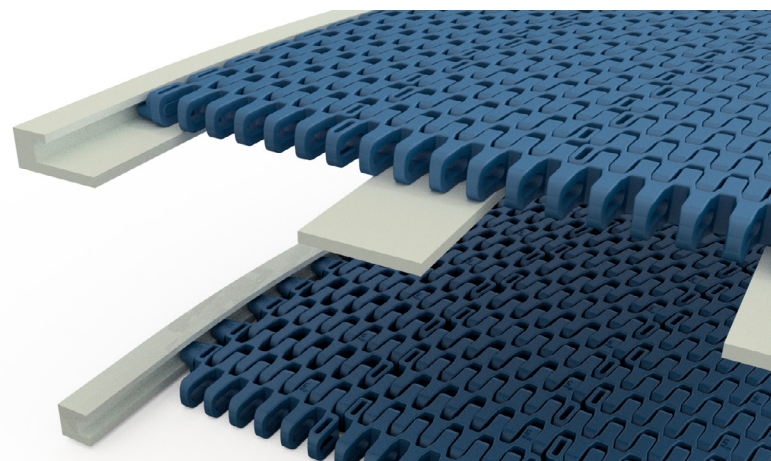

## Guide Rails

- All options below are natural UHMW with stainless steel (SS304, 14 gauge).
- For additional material or guide options, please contact your local sales representative.
- Fit commercially available clips and brackets
- Can be used as a guide rail, belt support, or wear strips.
- Meets FDA, USDA and pharmaceutical requirements.

### Round Top

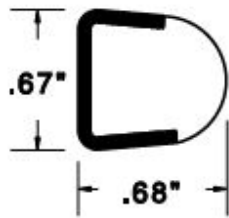

GRTT6768

### Flat Top

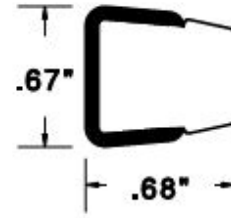

GRTT6768

### T-Top

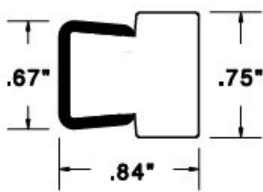

GRTT3484

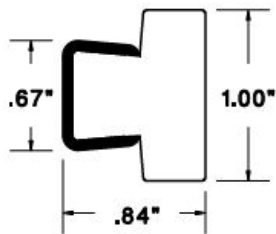

GRTT1084

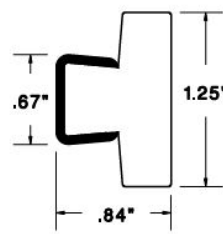

GRTT11484

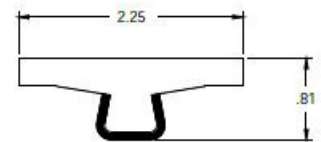

GRTT21481

### Edge Guide Belt Support

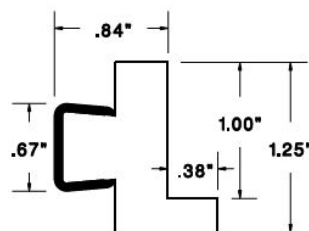

GRBS11484

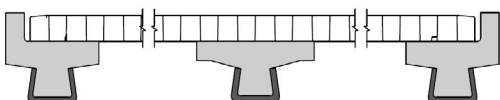



# Additional Components

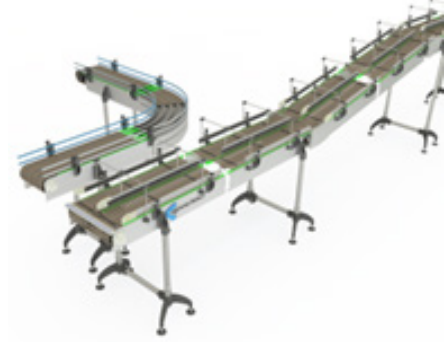

Contact us for **all** your component needs:

## Magnetic Tracks

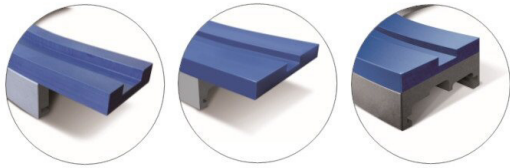

## Guide Rollers

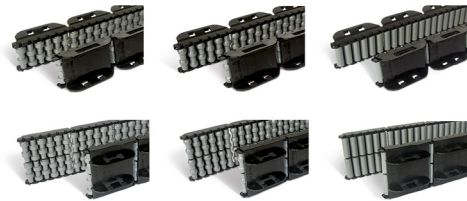

## Roller Chain Guide

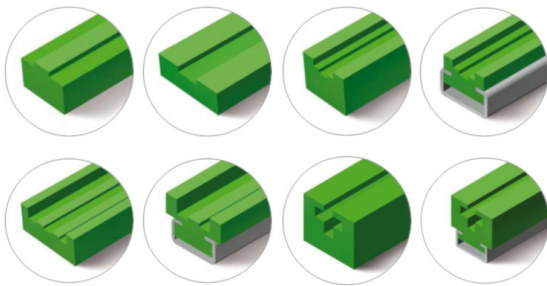

## Transfer Plates



## Return Profile Accessories

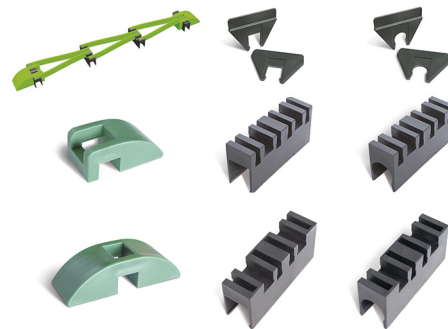

### Leveling Feet



### Support Bases



### Bearing Supports



### Brackets



### Clamps and Ratchets







# Contact your local supplier

The local partner of choice  
for sustainable conveyor belting solutions  
around the globe.

**Modular and Chain  
Ammeraal Beltech Modular USA**  
1157 Arnold Road  
Reading, PA 19605  
United States of America

T +1 800 937 2864  
[www.ammeraalbeltech.com/en-US/](http://www.ammeraalbeltech.com/en-US/)

**Synthetic  
Ammeraal Beltech USA**  
7501 N. St Louis Ave  
Skokie, IL 60076  
United States of America

T +1 800 533 3765



Scan the QR code  
and contact your  
local supplier!

